

6 kN coil absorber Typical System Layouts

1) TYPICAL SYSTEMS SUITABLE FOR REMOVABLE TRANSFASTENER.

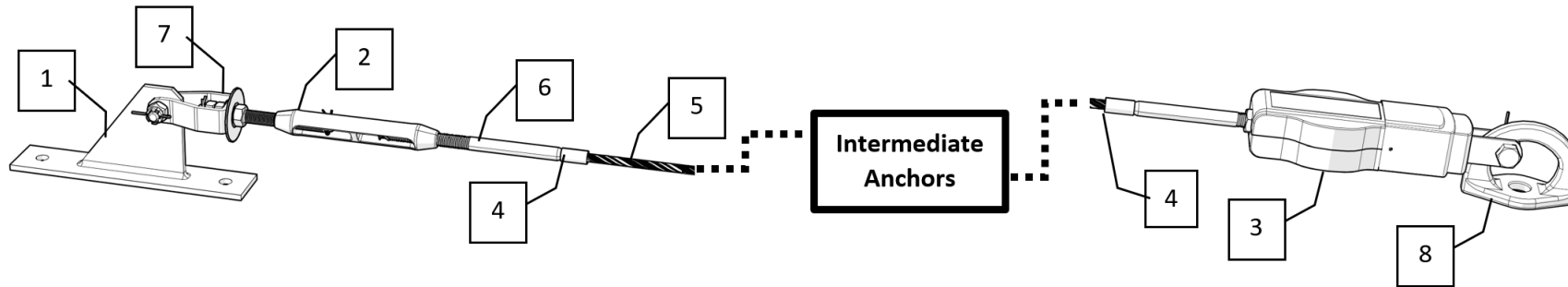

Item	REF	Description
1	85010-00	Shark fin end anchor
2	85050-00	Turnbuckle body
3	35416-00	6 kN coil absorber (swaged end)
4	85025-00	Swage slip indicator
5	L00900-14	7x7 stainless steel cable
6	85162-00	L/H threaded swage
7	85073-00	Line tensor (right hand thread)
8	85016-00	Heavy duty D-ring

MSA Latchways® Horizontal Lifelines

Technical datasheet:

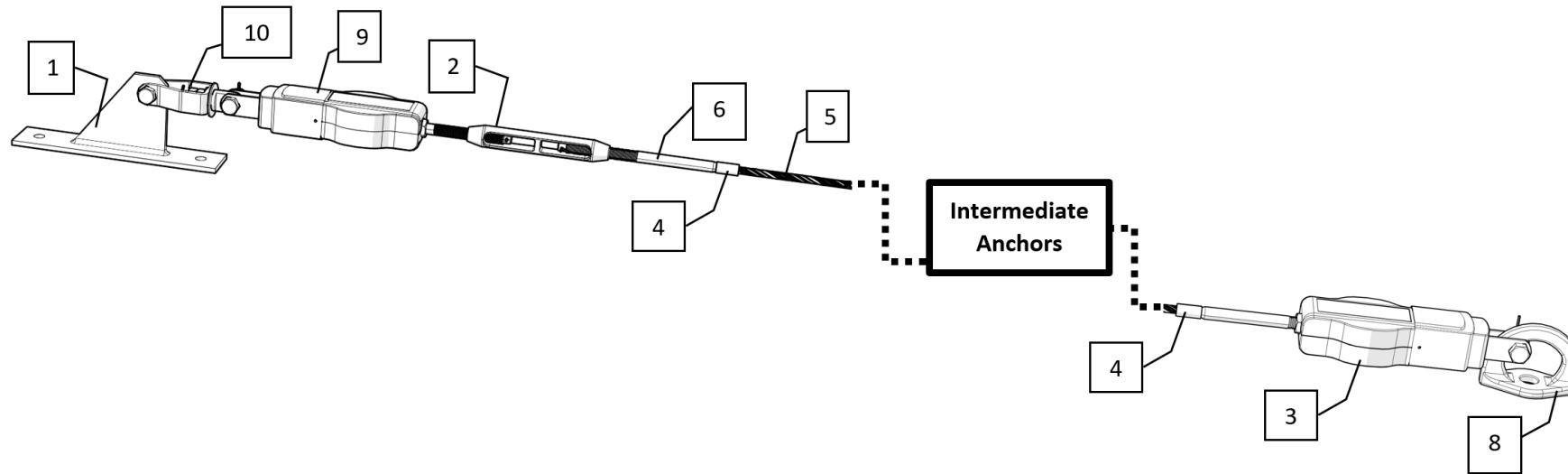

Item	REF	Description
1	85010-00	Shark fin end anchor
2	85050-00	Turnbuckle body
3	35416-00	6 kN coil absorber (swaged end)
4	85025-00	Swage slip indicator
5	L00900-14	7x7 stainless steel cable
6	85162-00	L/H threaded swage
8	85016-00	Heavy duty D-ring
9	35417-00	6 kN coil absorber
10	85071-00	Line tensor (eyelet)

MSA Latchways® Horizontal Lifelines

Technical datasheet:

2) TYPICAL SYSTEMS WITH ENTRY TERMINAL SUITABLE FOR STANDARD TRANSFASTENER.

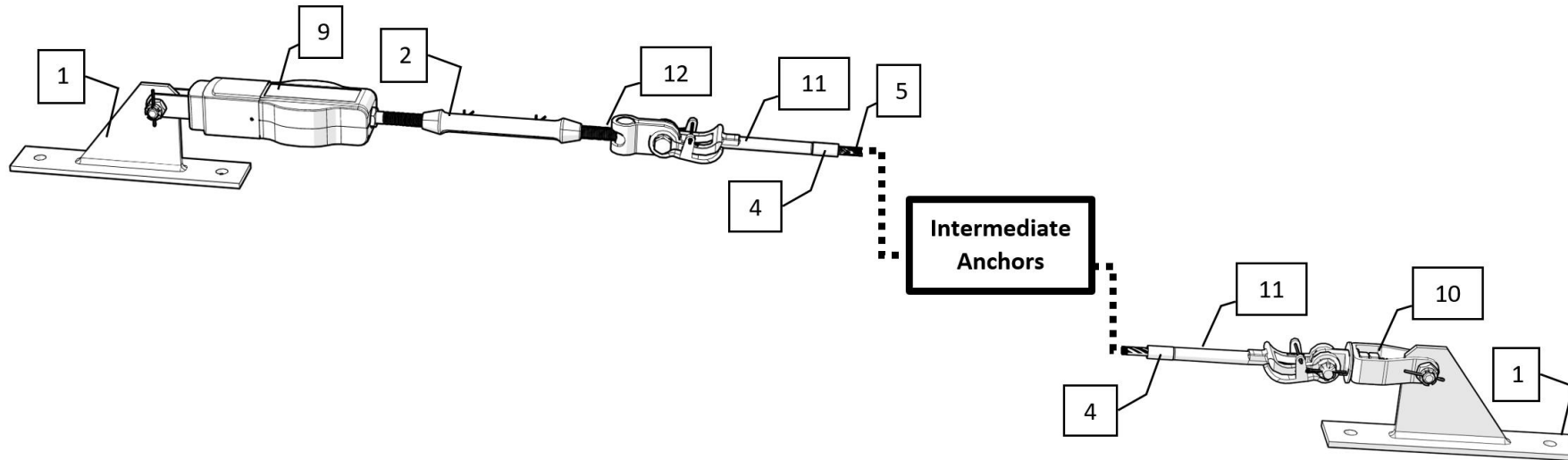

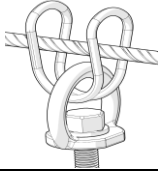
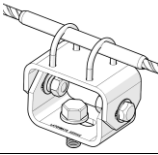
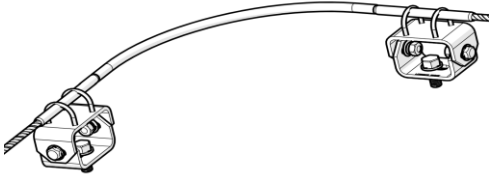
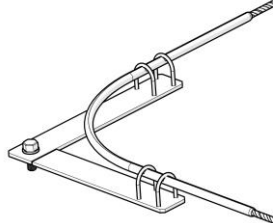
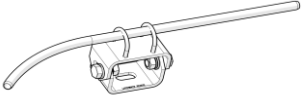

Item	REF	Description
1	85010-00	Shark fin end anchor
2	85050-00	Turnbuckle body
4	85025-00	Swage slip indicator
5	L00900-14	7x7 stainless steel cable
9	35417-00	6 kN coil absorber
10	85071-00	Line tensor (eyelet)
11	85020-00	Entry terminal
12	85056-00	Left hand thread male toggle

Intermediate anchor options



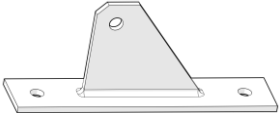
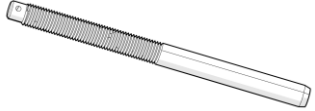
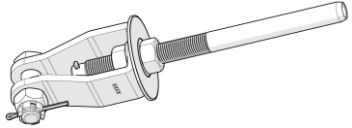

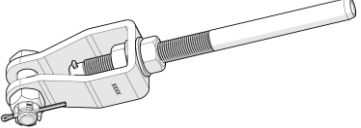
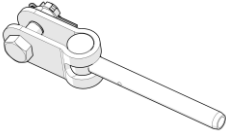
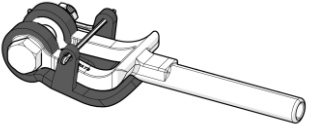
Component	Description
	<p>85030-00 + 85041-00 D-ring + Hanger Intermediate guide M12 intermediate anchor</p>
	<p>85060-00 Tube type intermediate guide M12 intermediate guide (Recommended for use in high wind or vibration exposure applications)</p>
	<p>(2 x 85060-00) + 85061-00 Three part corner combination to achieve 90° deviation for internal and external corners. M12 fixings required</p>
	<p>One piece 90° corner component 65012-00 M12 fixing 65018-00 M16 fixing</p>
	<p>85130-00 variable corner tube cable guide</p>
<p>Note: fixings and cable not included in the above intermediate part numbers.</p>	

Other components

End anchors			
REF	Description	REF	Description
	85016-00 Heavy Duty D-ring M16 end anchor		Shark fin end anchor 85010-00 - 2 x M12 fixing 85011-00 - left hand thread 85012-00 - joining swage-no 85013-00 - 2 x M12 heavy duty (see individual part datasheet for full information)
Swage connections			
	Threaded swage 85160-00 - Right hand thread 85162-00 - left hand thread (85161-00 - joining swage-no thread)		85390-00 Long run line tensor swaged
	85025-00 Swage slip indicator.		85391-00 Yoke end anchor connection swaged
	85057-00 Female swage toggle		85020-00 Entry/Exit terminal. Allows the Standard TransFastener to be inserted/removed from the cable.

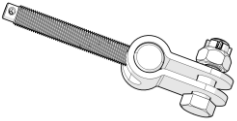
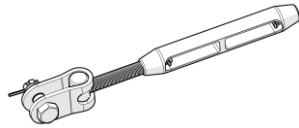
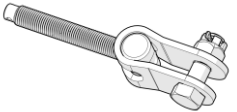
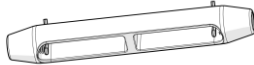
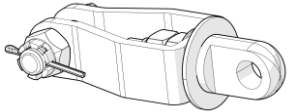
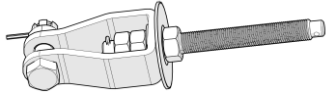
MSA Latchways® Horizontal Lifelines

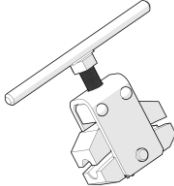

Technical datasheet:

<i>Tension components</i>			
REF	<i>Description</i>	REF	<i>Description</i>
	Male toggle 85056-00 Left hand thread 85054-00 Right hand thread		Turnbuckle and left hand threaded toggle 85052-00 Male toggle 85051-00 Female toggle
	Female toggle 85055-00 Left hand thread 85053-00 Right hand thread		85050-00 Turnbuckle body
	85071-00 Long run line tensor eyelet connection.		85073-00 Long run line tensor right hand threaded.
<i>Miscellaneous components</i>			
	85030-00 D-Ring. Used for intermediate connections.		85041-00 Hangers. Used for intermediate connections.
	85048-00Y Articulating D-Ring.		85170-00 Bending tool. (used to form bends in variable corner guide tubes)

MSA Latchways® Horizontal Lifelines

Technical datasheet:

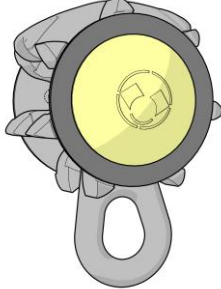
MSA Latchways® Mobile Anchor Points (MAPs)

REF	Description
	<p>85080-00 Latchways Standard TransFastener. Requires an Entry/Exit terminal to be connected to the system.</p>
	<p>85085-00 Latchways Removable TransFastener. Can be connected to a system without the need for an entry/exit terminal.</p>

IMPORTANT

Information is provided for guidance only. The components detailed in this document may be interchanged to achieve the required system design.



WARNING!

All components shall be installed in accordance with the relevant data sheet and in accordance with MSA Latchways® installation instructions.



WARNING!

All systems shall be designed using the appropriate MSA Latchways® software. Failure to do so could result in poor system performance or possible failure.

MSA Latchways® Horizontal Lifelines

Technical datasheet:



Revision history

Reference	Date issued	Revision
RFEA7515	Sept-2021	-03